

# 75 S Installation Manual

## Tools Needed



Hand drill



Impact drill



Allen wrench



Spanner



Spirit level



Ladder



Gloves



Helmet

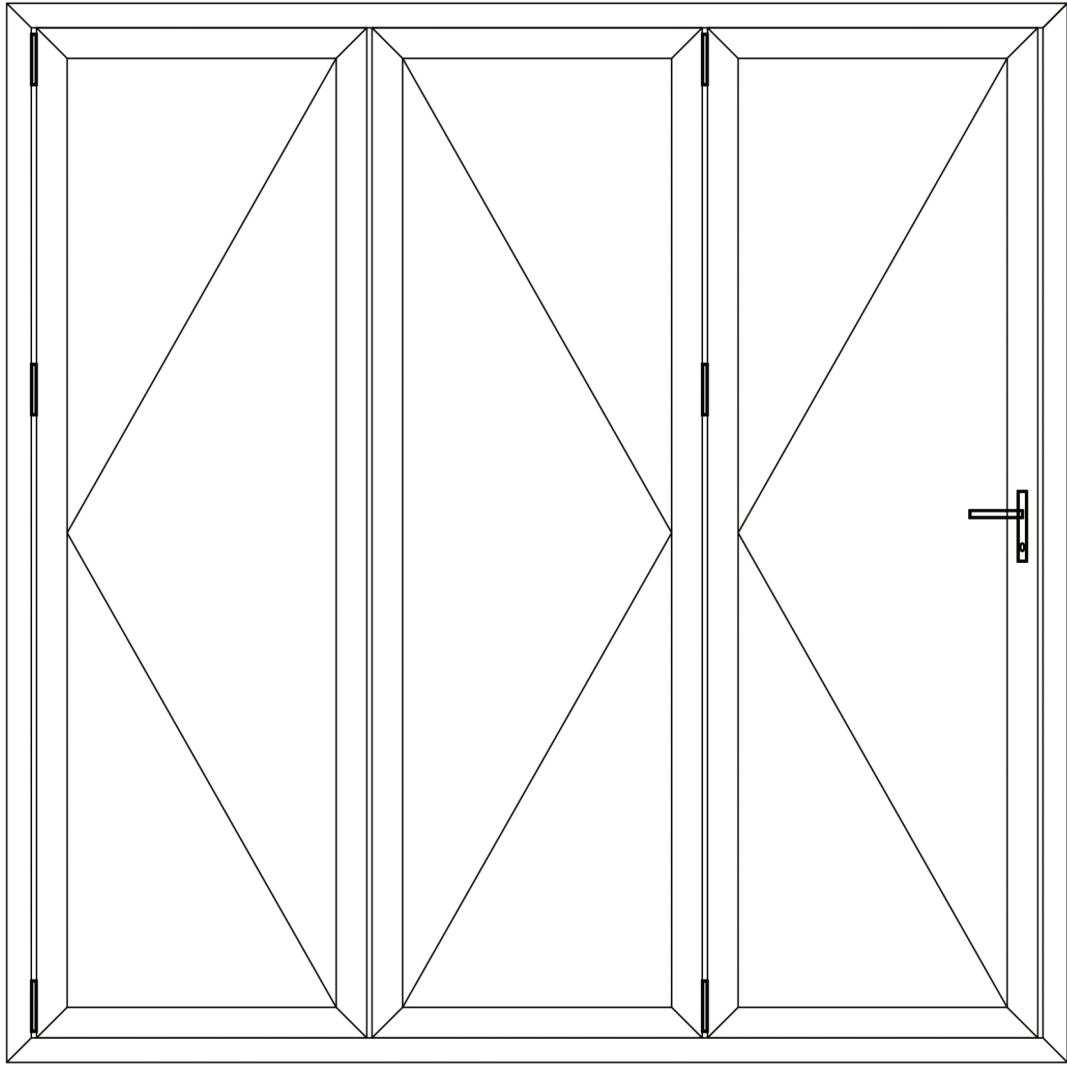

# Finished product

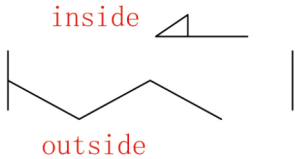
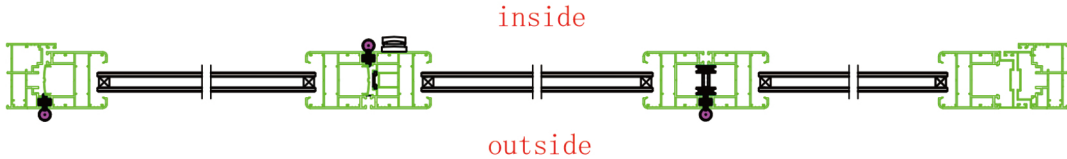
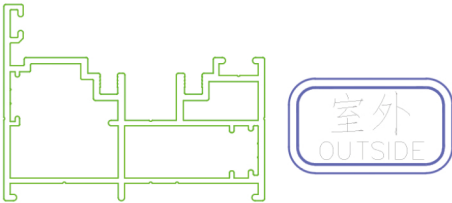

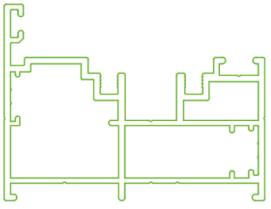

Outer frames

Left outdoor  
(A3+0)

UP outdoor

Right outdoor  
(A3+0)

Down outdoor

Labels on outer frames



## Frames of door panels

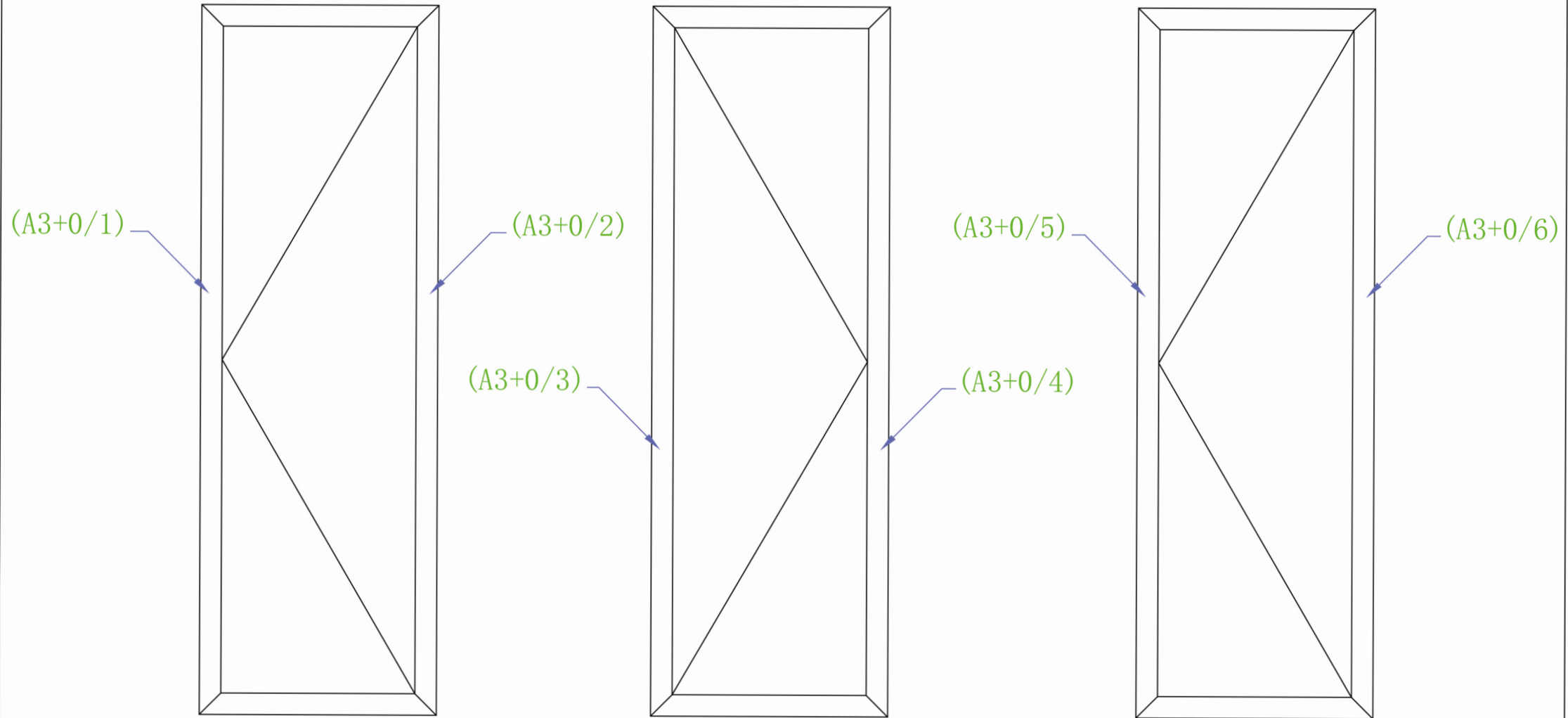

Labels one door panels

Assembly of the outer frame: Use conner joint to assemble the outer frames.

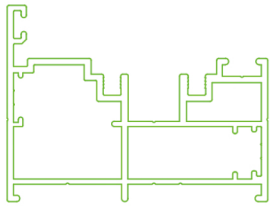

Outer frames

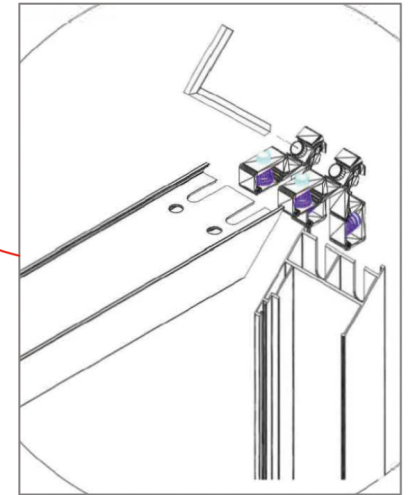
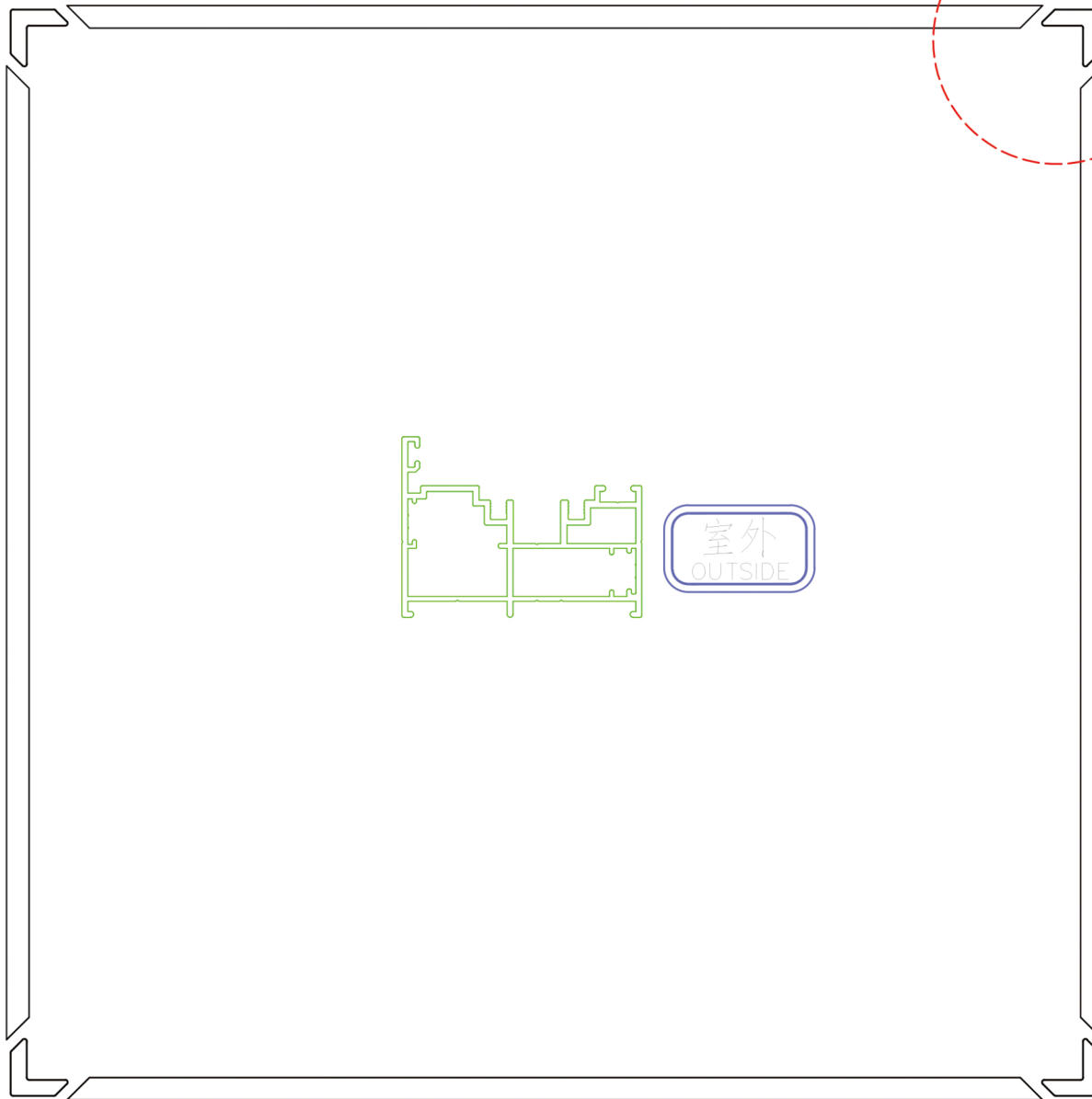

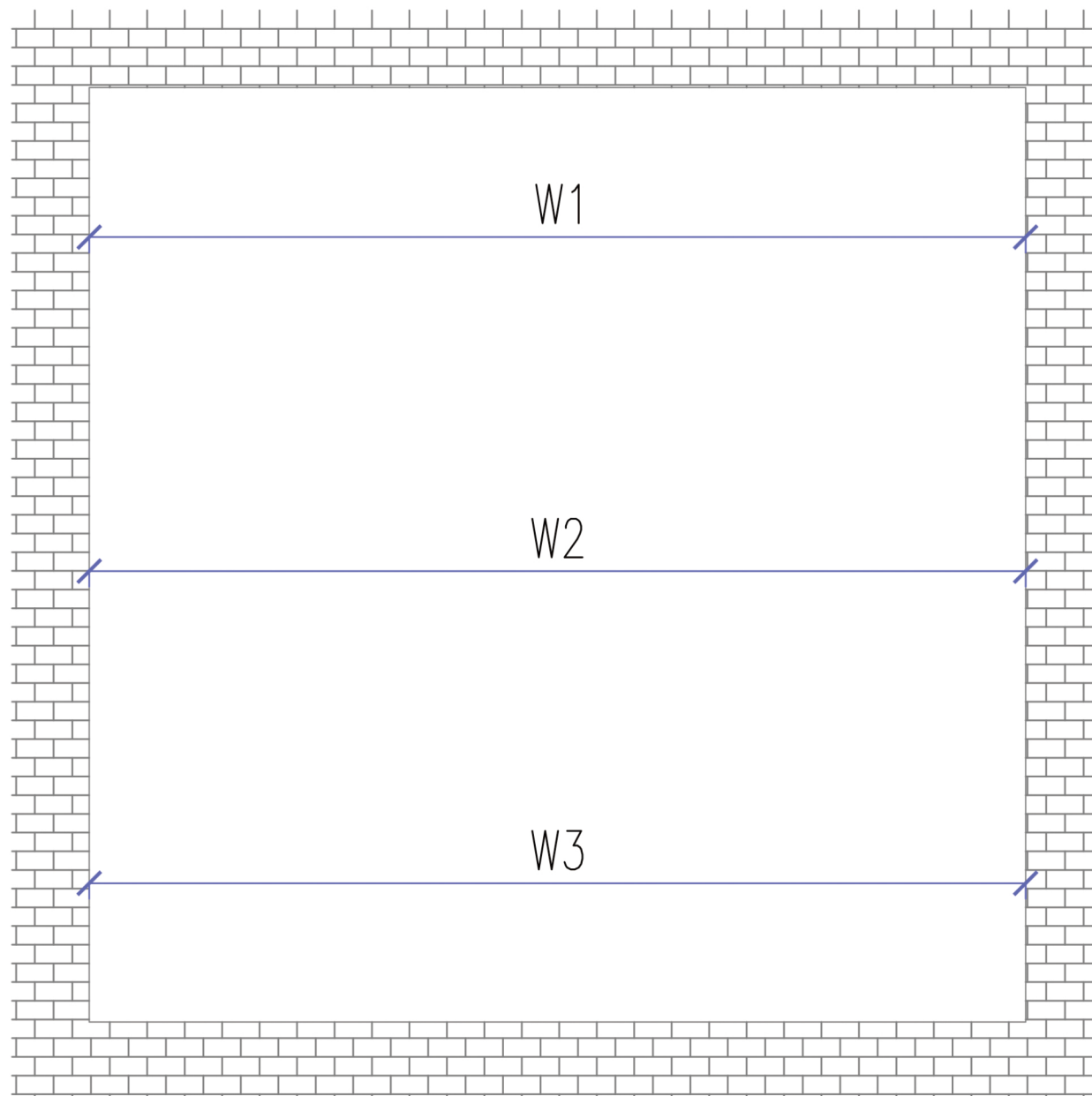

Measure the width of the door opening before installing the outer frame: Choose three different horizontal lines on the door opening to measure separately, and then take the average of the three measurements.

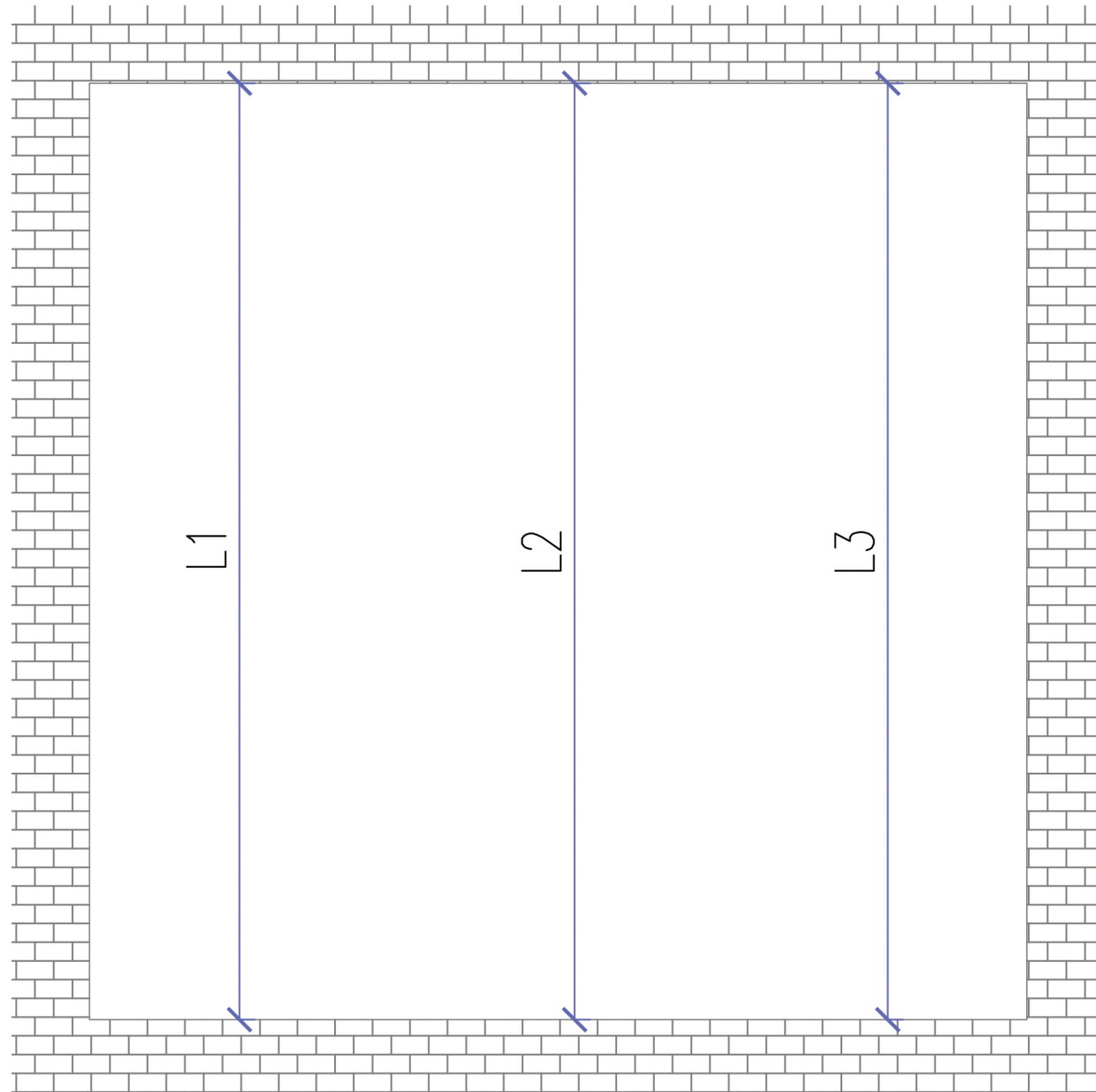

Measure the height of the door opening before installing the outer frame: Choose three different vertical line on the door opening to measure separately, and then take the average of the three measurements.

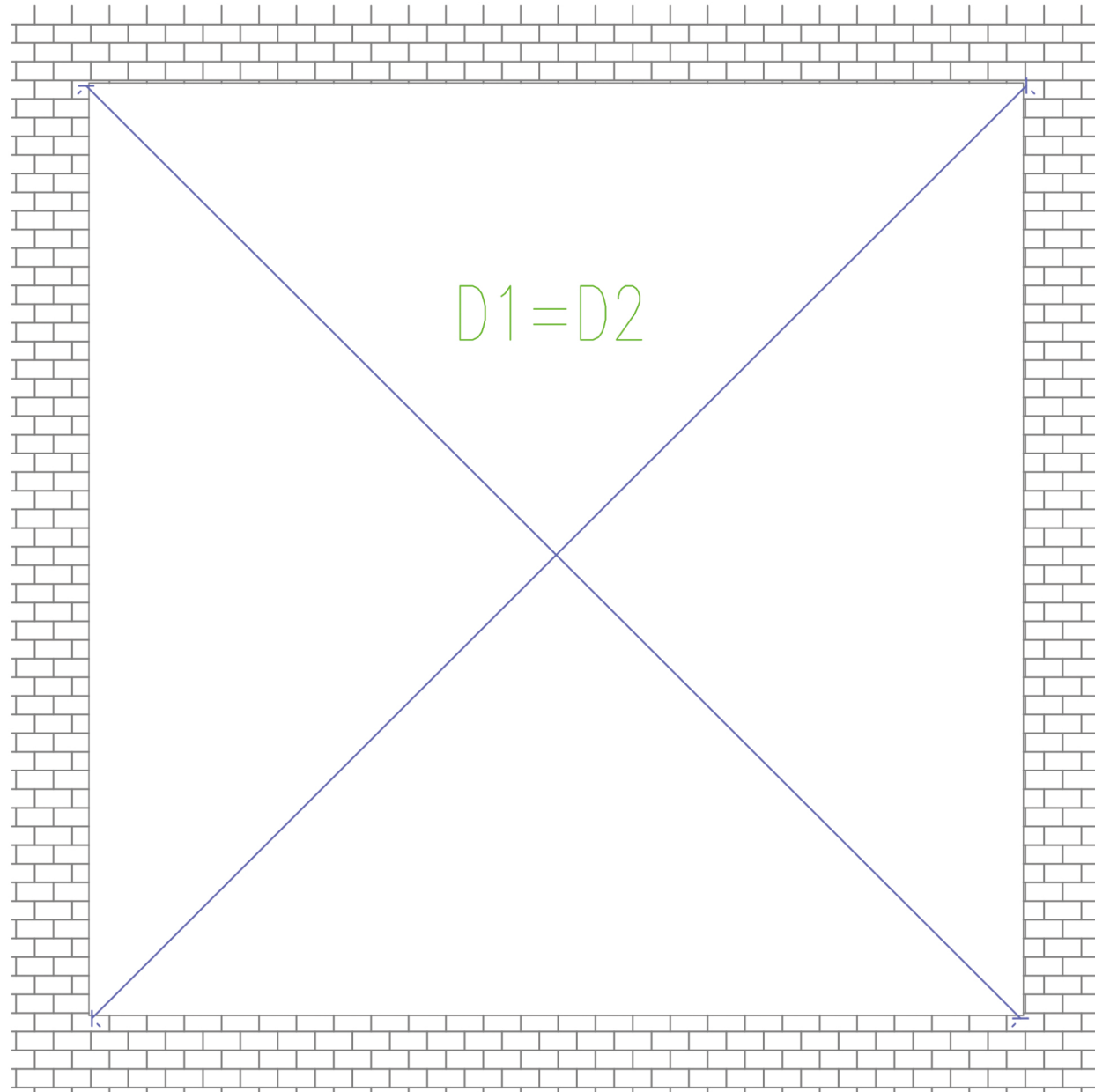

Measure the two diagonals of the door opening to make sure they are equal in length.

Please screw the screws on the outer frame according to the position shown in the picture to fix the outer frame

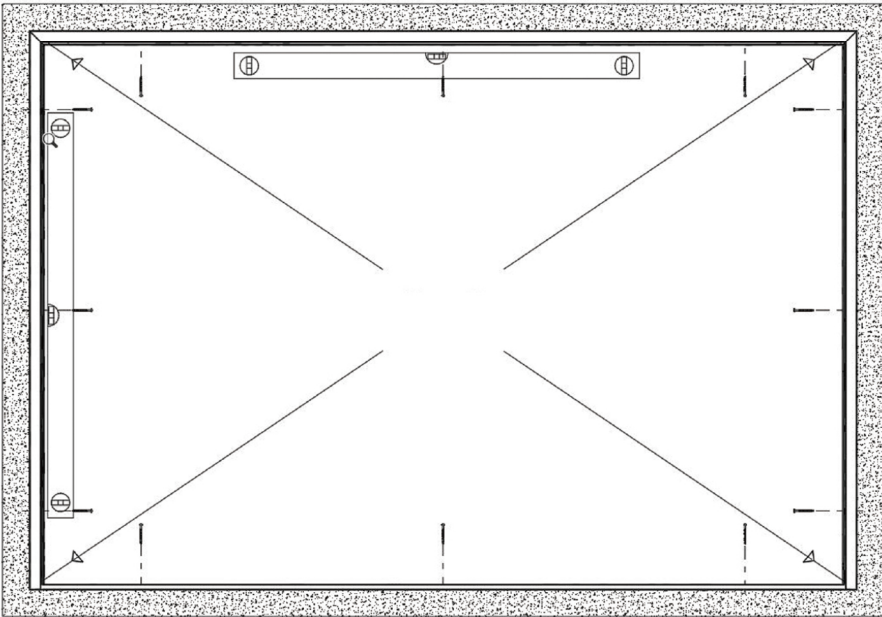
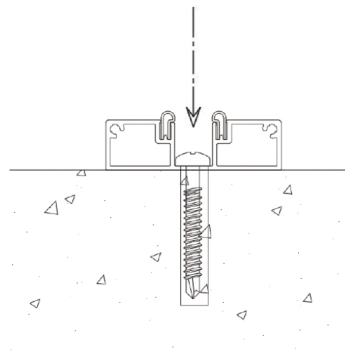
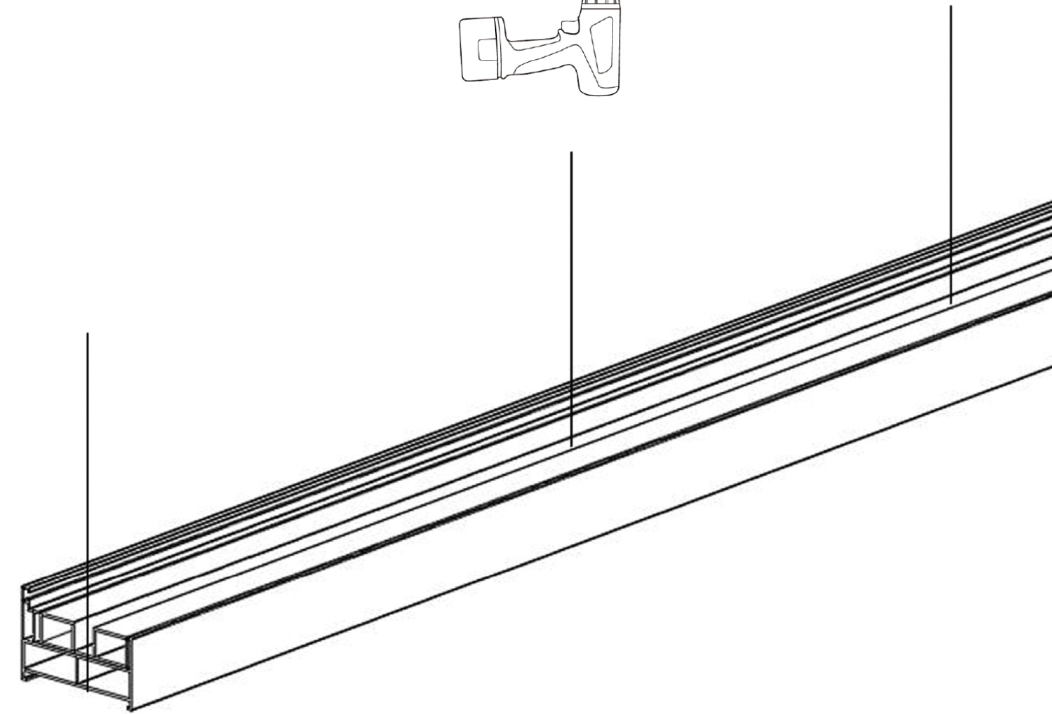
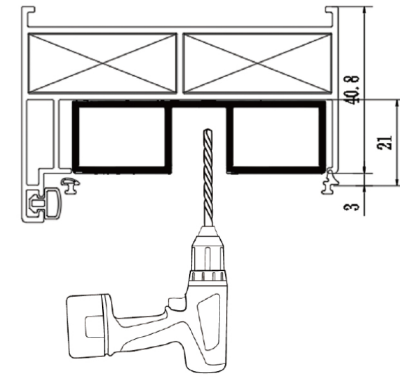
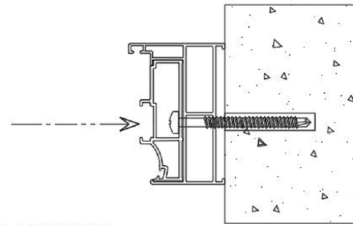
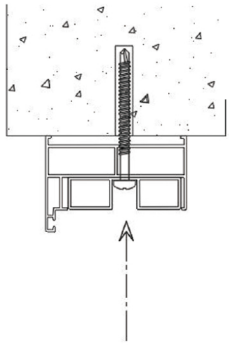

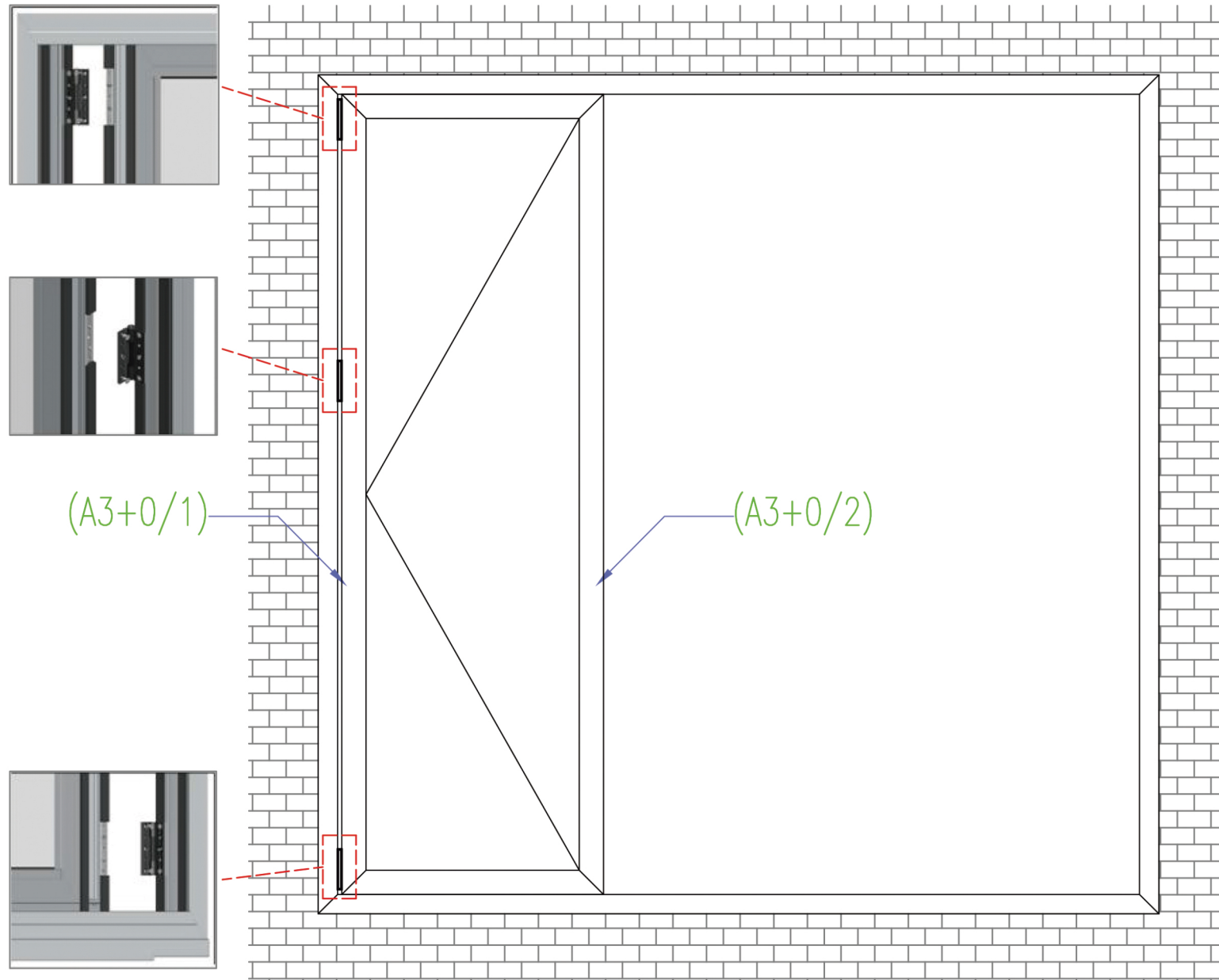

Find the door panel with the label shown in the picture, and use self-tapping screws to fix its hinges (The hinges are on side A3+0/1) to the frame.

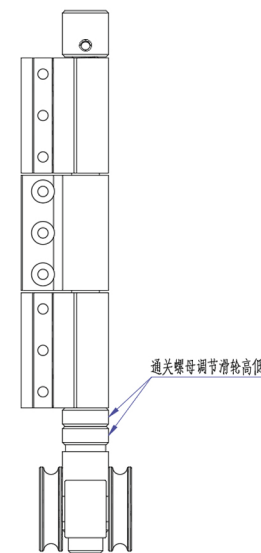
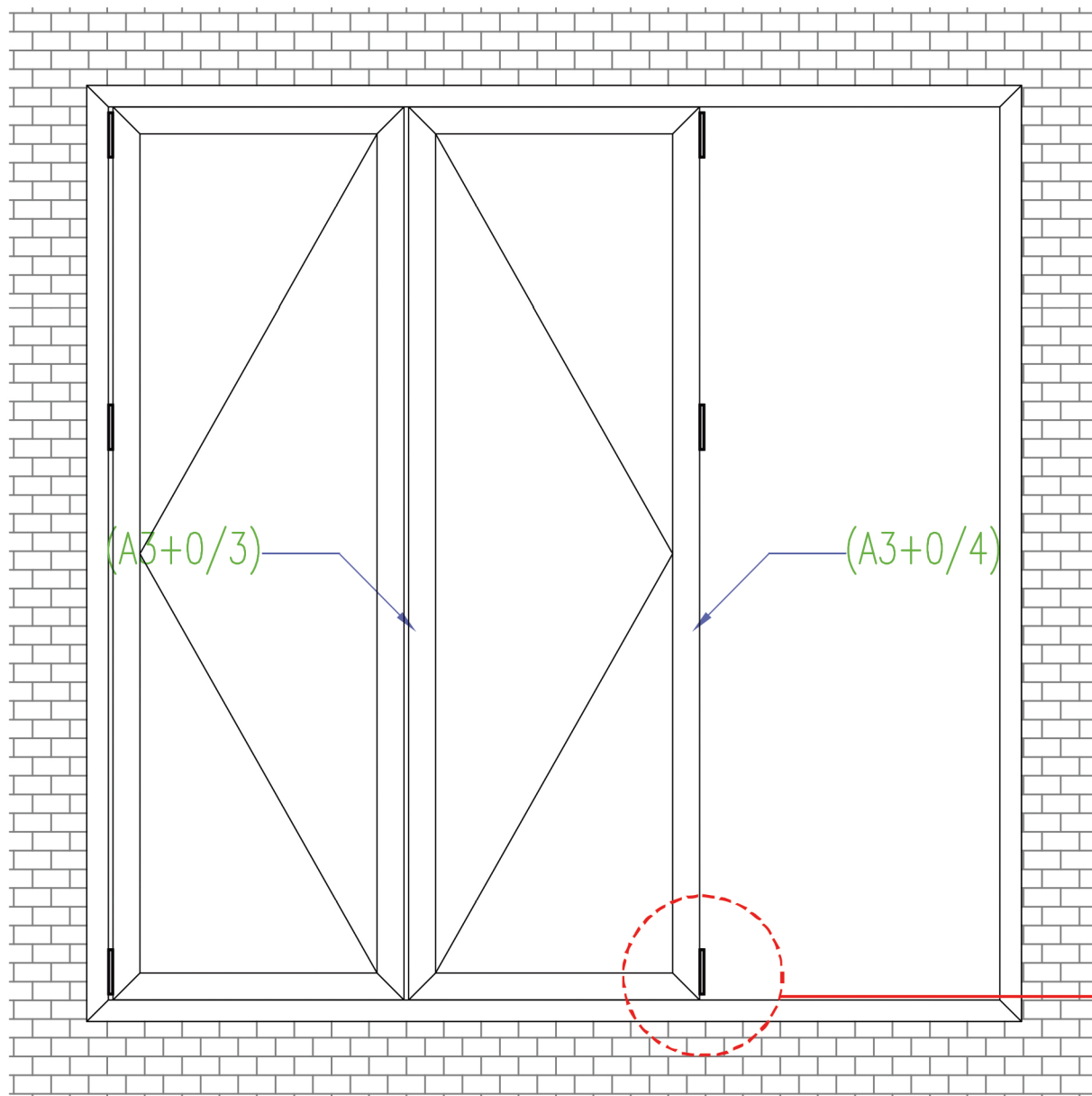

locate the door panel with the label shown and place its guide wheels in the top rail. Use self-tapping screws to secure it to the left door panel.

The first door panel needs to be opened when placing the 2nd door panel.  
Tilt the 2nd panel on the indoor side and place the bottom load-bearing wheels on the bottom track then place the guide wheels in the top track.

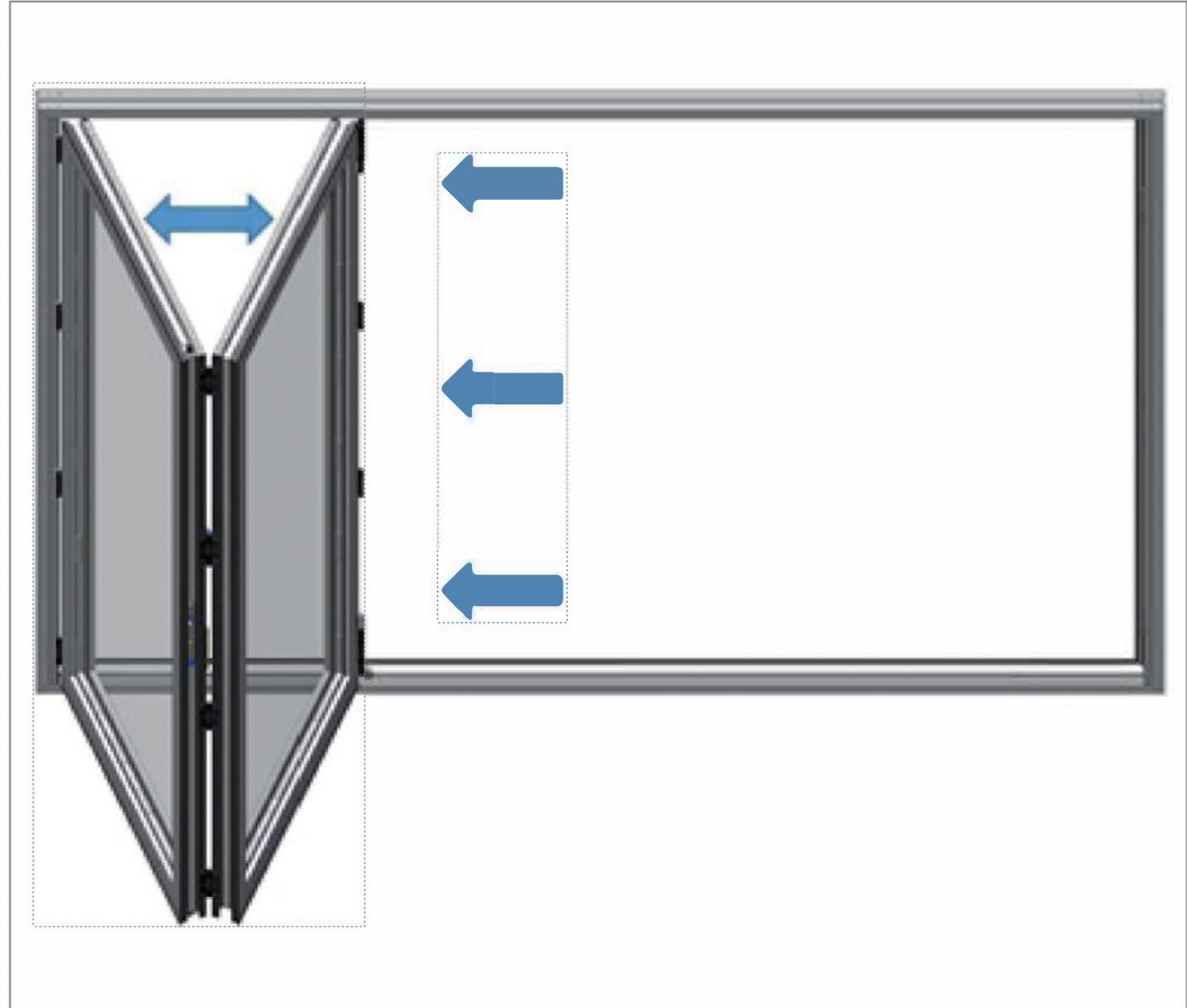
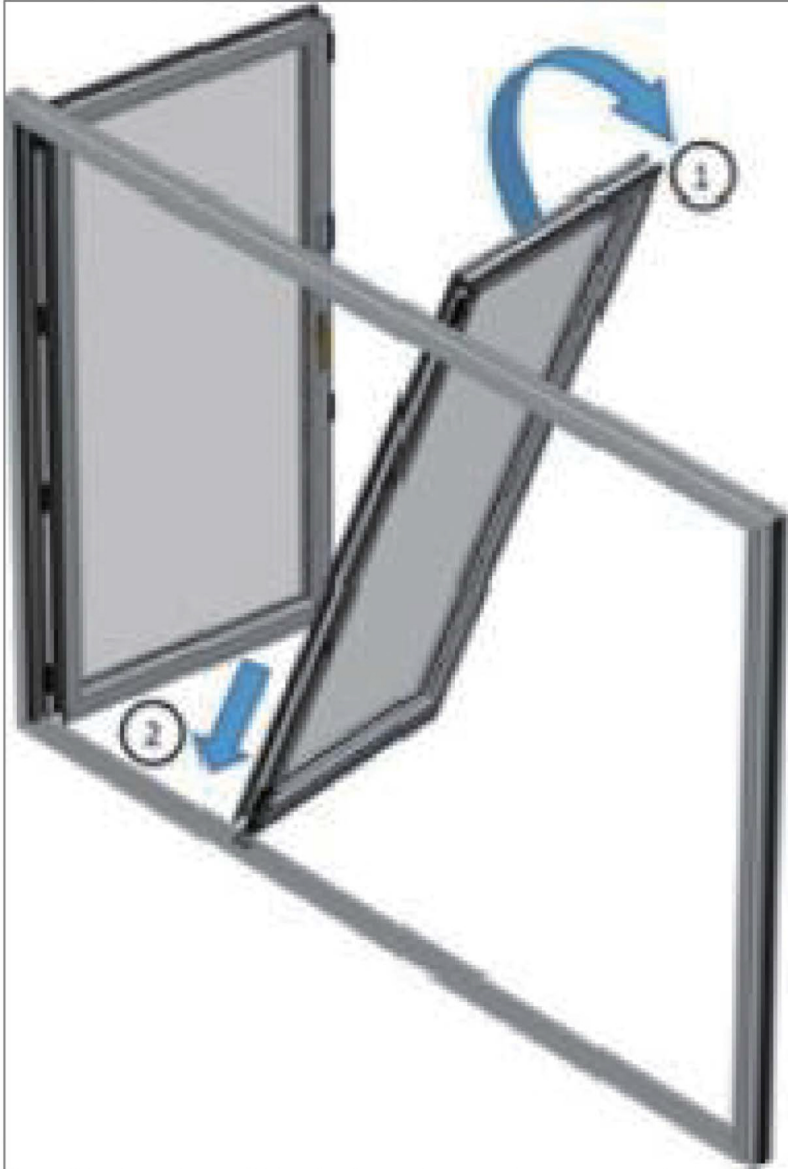

slide the 2nd panel next to the 1st panel on the interior side and secure the hinges on the 2nd panel using self-tapping screws.

Use the same method to install the 3rd door panel.

**Install the handle and lock after the door panels are installed:**

- 1. Insert the lock into the lock slot, fix it with screws**
- 2. Insert the lock cylinder from the indoor side**
- 3. Insert the handle shaft from the indoor side**
- 4. Fix the handle and cover plate with screws**

